

Title POWER & RESET	
File: C:\project\craft\usb_interface\usb_interface_v0r9.ddb - v0r9/power_reset.sch	
Number: 1	Revision: 0
Date: 15-Mar-2006	Sheet 3 of 7

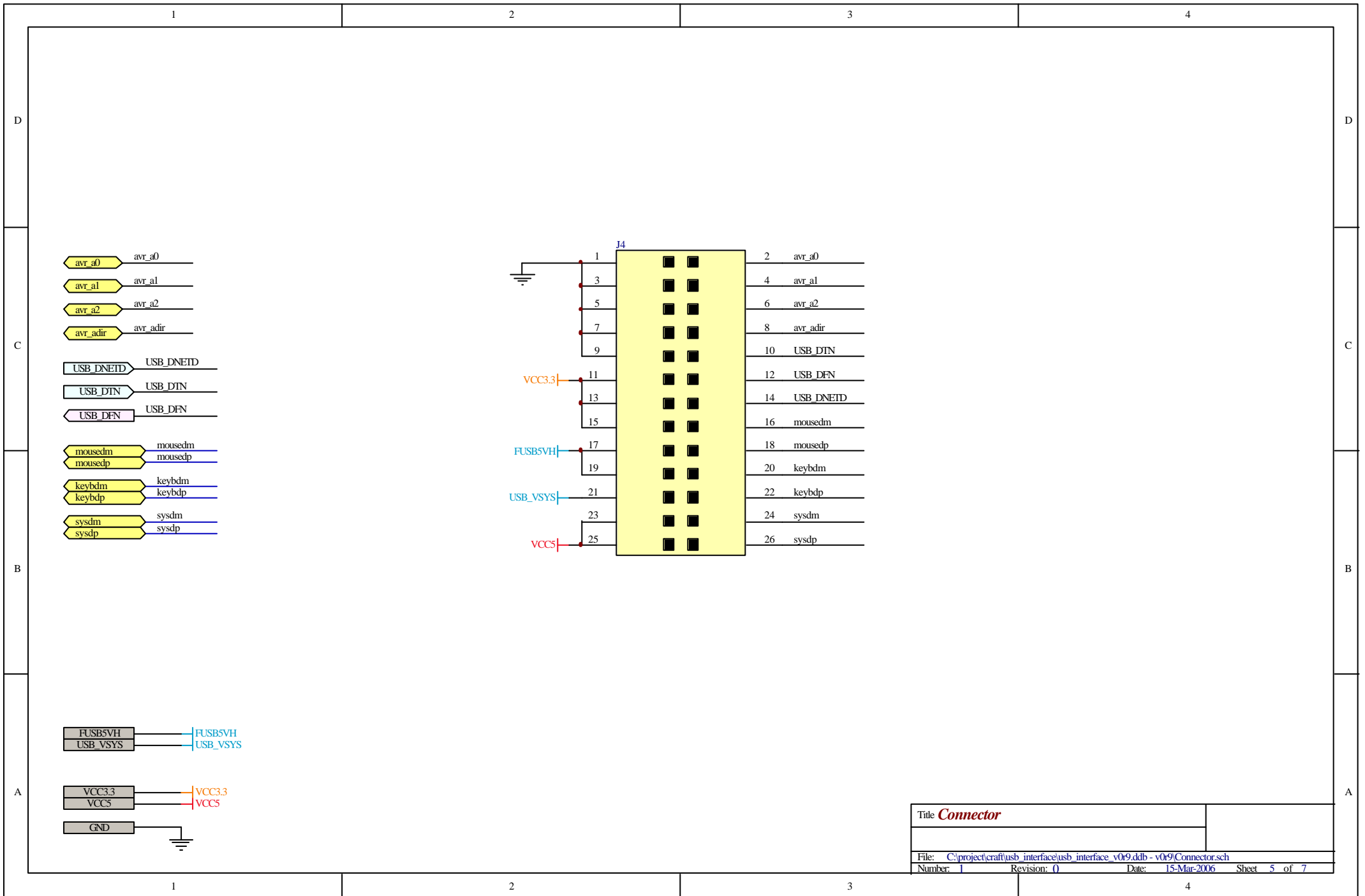

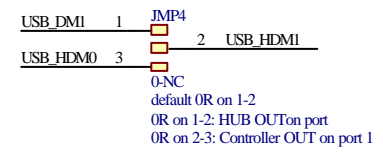

Title USB HUB			
File: C:\project\craft\usb_interface\usb_interface_v0r9.ddb - v0r9\USB_HUB.sch			
Number: 1	Revision: 0	Date: 15-Mar-2006	Sheet 6 of 7

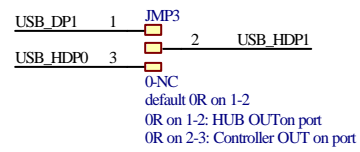
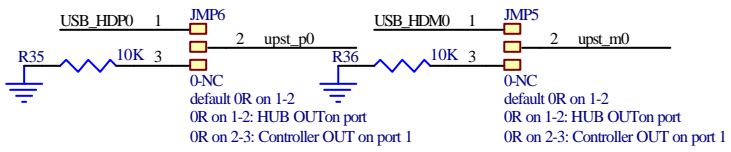
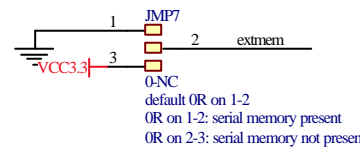
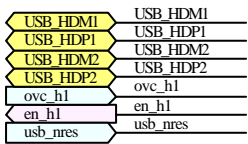
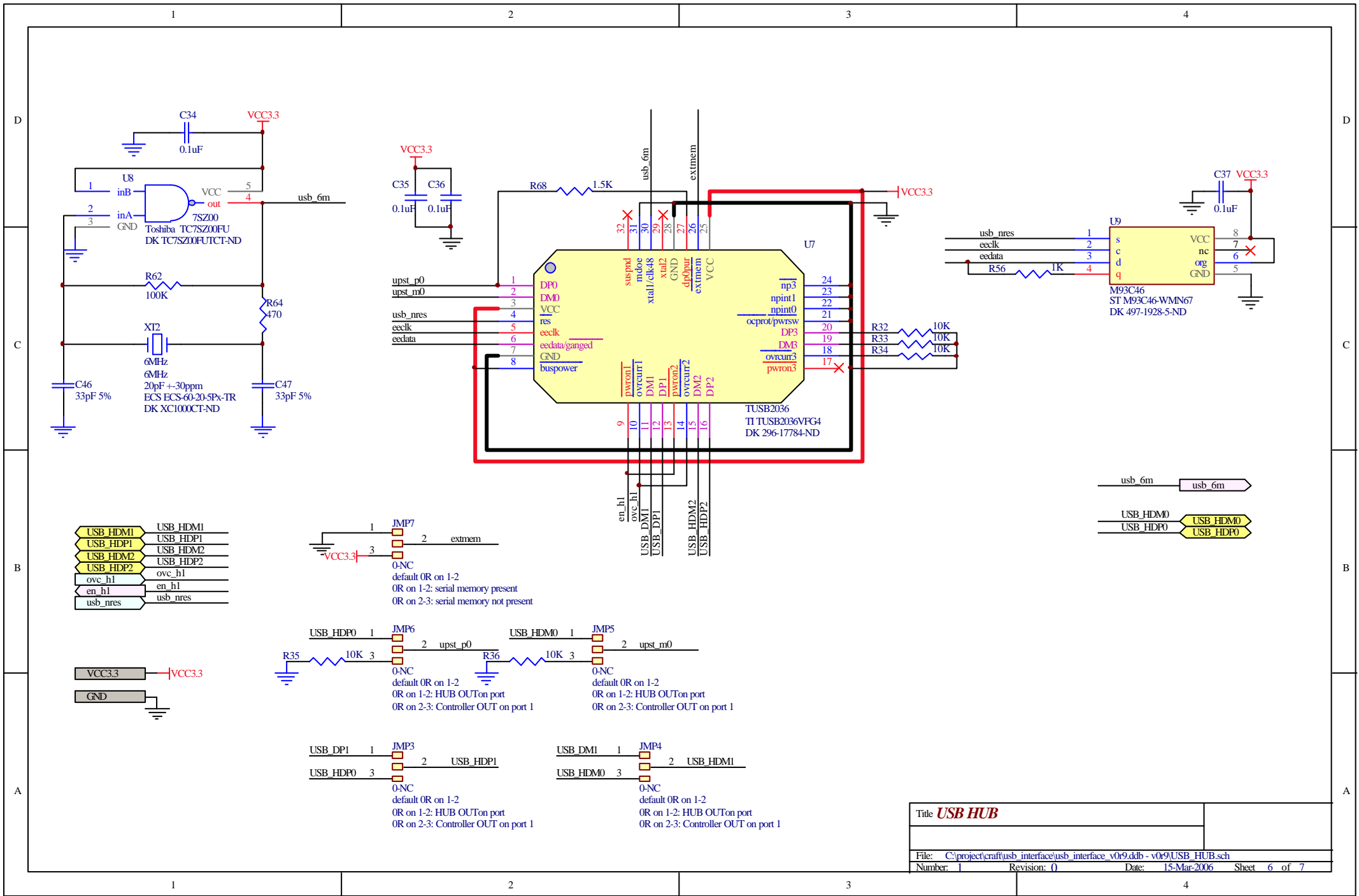
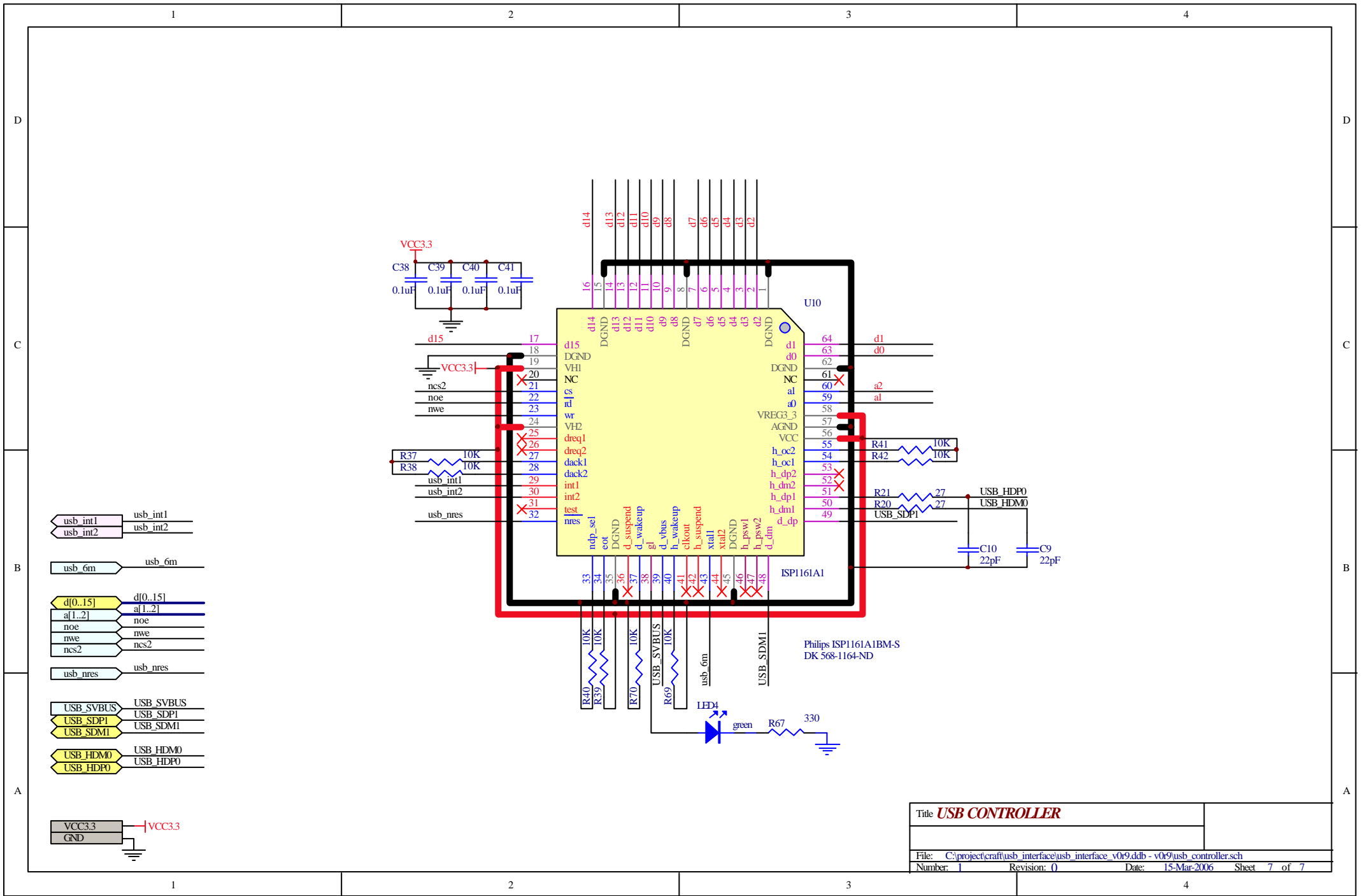

- usb_int1
- usb_int2
- usb_6m
- d[0..15]
- a[1..2]
- noe
- nwe
- ncs2
- usb_nres
- USB_SVBUS
- USB_SDP1
- USB_SDM1
- USB_HDM0
- USB_HDP0

Title USB CONTROLLER	
File: C:\project\craft\usb_interface\usb_interface_v0r9.ddb - v0r9\usb_controller.sch	
Number: 1	Revision: 0
Date: 15-Mar-2006	Sheet 7 of 7